



GB LED UPGRADE KIT
Installation Instruction

D LED UPGRADE BAUSATZ
Einbauanleitung

E LED EQUIPO MODERNIZACIÓN
Instrucciones de montaje

F LED TROUSSE AMÉLIORER
Instructions de montage

I LED ATTREZZATURA AGGIORNAMENTO
Istruzioni di montaggio

P LED ESTOJO ATUALIZAÇÃO
Instruções de montagem

NL LED UPGRADE KIT
Inbouw-instructie

DK LED OPGRADERINGKIT
Monteringsvejledning

N LED OPPGRADERINGKIT
Monteringsveiledning

S LED UPPGRADERINGSATS
Monteringsanvisning

SF LED NADGRADNJA KIT
Asennusohje

CZ LED UPGRADE SÚPRAVA
Návod k montáži

H LED FRISÍTÉS KÉSZLET
Beszerelési utasítás

PL LED ZESTAW AKTUALIZACJA
Instrukcja zabudowy

GR LED ΠΑΚΕΤΟ ΑΝΑΒΑΘΜΙΣΗ
Οδηγίες τοποθέτησης

RUS LED КОМПЛЕКТ МОДЕРНИЗАЦИЯ
инструкция по установке

SVK SADA NA AKTUALIZÁCIU LED
Návod na inštaláciu

[SDN]



MAZDA 3 BL

*MZBM*****
*MZBN*****

[WGN]



[SDN]



MAZDA 6 GJ

MAZDA 6 GH

JMZGJ *****120400 ➡
JMZGL *****500015 ➡

Part Number: 4100-78-828A
4100-78-829B
4100-78-830B

Mazda3 (SDN)
Mazda6 (WGN)
Mazda6 (SDN)

Date: 19-09-2019

© Copyright MAZDA

Sheet 1 of 16

Expert Fitment Required
Montage durch Fachwerkstatt erforderlich
Montaje sólo por el concesionario
Montage par spécialiste nécessaire
E' necessario in officina specializzata
Especialista em montagem requerido
Montage door vakman nodig
Montage ved professionelt værksted påkrævet
Nødvendig med montering fra fagværksted
Verkstadsmontage erfordras
Asennus tarpeen merkikorjaamossa
Montáž ve specializované dílně nutná
A szereléshez szakműhely kell
Konieczny montaż przez warsztat specjalistyczny
Να τοποθεήσει από συνεργείο
Необходима установка специалистами
Výžaduje sa odborné vybavenie

GB**INSTRUCTION SHEET**

- Not For Do It Yourself Fitment.
- Check Radio Code.
- Disconnect Battery Negative Terminal.
- To avoid damage to wiring harness, ensure contact with sharp edges is prevented.
- Ensure that the wire harness is routed and fixed in the correct position
- Install parts as shown on Illustrations.
- Re-fit panels, ensure that the wiring harness and other components are neatly and securely located.

D**EINBAUANLEITUNG**

- Nicht für Selbstmontage.
- Notieren Sie den Radio Code.
- Massekabel von Batterie abklemmen.
- Zur Vermeidung von Beschädigungen an der Kabelisolation ist Berührung mit scharfen Kanten zu vermeiden.
- Achten Sie darauf, daß der Kabelbaum an der richtigen Stelle verläuft und ordnungsgemäß befestigt ist.
- Teile gemäß Abbildung montieren.
- Paneele wieder anbringen; achten Sie darauf, dass der Kabelbaum und andere Teile ordnungsgemäß und genau positioniert sind.

E**ISTRUCCIONES DE MONTAJE**

- No para montarlo uno mismo.
- Anote el código de seguridad de la radio.
- Desconectar el cable de masa de la batería.
- A efectos de evitar desperfectos en el aislamiento del cable, hay que evitar el contacto con aristas cortantes.
- Preste atención a que el mazo de cables transcurra por el lugar correcto y esté fijado correctamente.
- Montar las piezas tal como se indica en las figuras.
- Volver a colocar los paneles; preste atención a que el mazo del cable y las demás piezas tengan la posición correcta y precisa.

F**NOTICE DE MONTAGE**

- Le montage doit être effectué par un spécialiste.
- Noter le code de l'autoaudio.
- Débrancher le câble de masse de la batterie.
- Eviter tout contact avec des arêtes vives afin de ne pas endommager l'isolation des câbles.
- Veiller à ce que le faisceau de câbles passe au bon endroit et soit correctement fixé
- Monter les pièces selon les figures.
- Remettre le panneau; veillez à ce que le faisceau et les autres pièces soient positionnés correctement et avec la précision requise.

I**ISTRUZIONI DI MONTAGGIO**

- Non per „do-it-yourself“.
- Annotare il codice di sicurezza della radio.
- Staccare il cavo di massa dalla batteria.
- Allo scopo di evitare danni all'isolazione dei cavi, evitare di metterli a contatto con spigoli acuti.
- Fate attenzione, che il fascio di cavi sia posato al posto giusto e fissato a regola d'arte.
- Montare le parti secondo quanto rilevabile dalle illustrazioni.
- Rimettere in posizione i pannelli; far ben attenzione che il fascio di cavi e le altre parti siano state posizionate con esattezza e nella dovuta maniera.

P**INSTRUÇÕES DE MONTAGEM**

- No é destinado à „auto-montagem“.
- Tome nota do número de código do rádio.
- Separe o cabo de terra do acumulador.
- Para não se danificar a isolamento dos cabos, é conveniente evitar-se contacto com arestas afiadas.
- Restar atenção para que o conjunto de cabos seja colocado no lugar correcto.
- Monte as partes conforme ilustrado.
- Tornar a colocar os painéis; verificar se a árvore de cabos e outras peças estão na posição exacta e prescrita.

NL**INBOUW-INSTRUCTIE**

- Niet voor doe-het-zelf-montage.
- Radio Code noteren.
- Massakabel van accu losmaken.
- Ter vermijding van beschadiging aan de isolatie van de elektrofit dient contact met scherpe kanten te worden vermeden.
- Let erop, dat de kabelboom op de juiste plaats ligt en correct bevestigd is.
- Delen overeenkomstig afbeelding monteren.
- Panelen weer monteren; let erop, dat de kabelboom en andere delen correct en precies geïmplementeerd worden.

DK**MONTERINGSVEJLEDNING**

- Ikke til „do-it-yourself“ montering.
- Noter radiokoden.
- Stelkabel fjernes fra batteri.
- Berøring med skarpe kanter skal undgås for at undgå beskadigelse af kabelisoleringen.
- Vær opmærksom på, at kabelsamlingen trækkes på det rigtige sted og er fastgjort korrekt.
- Dele skal monteres i henhold til illustrationer.
- Paneler fastgøres igen; vær opmærksom på, at kabelsamlingen og andre dele placeres korrekt og præcist.

N**MONTERINGSVEILEDNING**

- Ikke for selvmontage.
- Noter deg radiokoden.
- Iem jordkabelen av batteriet.
- For å unngå skader på kabelisoleringen må berøring av skarpe kanter unngås.
- Pass på at kabeltreet forløper på riktig sted og er skikkelig festet fast.
- Monter alle deler i henhold til illustrasjonene.
- Monter panelene igjen, og pass på at kabel-enten og andre deler er anbrakt ordentlig og på riktig sted.

S**MONTERINGSANVISNING**

- Ej för självmontage.
- Anteckna radiokoden.
- Lossa stomkabeln från batteriet.
- För att förhindra skador på ledningarnas isolation skall beröring med vassa kanter undvikas.
- Se till att ledningsstammen dras på rätt ställe och är ordentligt fäst.
- Montera detaljerna enligt figurerna.
- Sätt tillbaka panelerna igen; kontrollera nogga att ledningsmattan och andra detaljer ligger på rätt plats.

SF**ASENNUSOHJE**

- Ei „Tee-se-itse-asennukseen“.
- Merkitse radion koodi muistiin.
- Erota maadoitusjohto akusta.
- Katso, että kaapelit eivät osu teräviin kulmiin. Ne saattaisivat vaurioitua.
- Pidä huoli myös siitä, että kaapelointi on korin kiinnityksen myötäinen ja kiinnitetty huolellisesti muihin liikkuviin osiin.
- Asenna osat kuvien mukaan.
- Aseta paneelit paikalleen; tarkista, että kaapelointi ja muut osat ovat asianmukaisesti ja varmasti paikoillaan.

CZ**NAVOD K MONTÁŽI**

- Není určeno pro neodbornou montáž.
- Poznamenejte si kód rádia.
- Odpojte zemnicí kabel od baterie.
- Zabraňte styku s ostrými hranami, aby nedošlo k poškození kabelové izolace.
- Dbejte na to, aby byl svazek kabelů položen na správném místě a aby byl řádně upevněn.
- Montujte části podle vyobrazení.
- Opět připevněte panely; dbejte na řádné a přesné umístění svazku kabelů a ostatních částí.

H**BESZERELESI UTASITAS**

- A beszerelést Ön saját maga nem végezheti el.
- Jegyezze meg a rádió biztonsági kódszámát.
- Húzza le az akkumulátor testkábéljét.
- A kábelszigetelés megsérülésének elkerülésére ügyeljen arra, hogy a kábel ne juthasson érintkezésbe éles permű alkatrészekkel.
- Ügyeljen arra, hogy a kábelek a számkra kijelölt helyen helyezkedjenek el és megfelelően rögzítve legyenek.
- Az alkatrészeket az ábra szerint szerelje be.
- Szerelje vissza a fedőlapokat, ügyeljen arra, hogy a kábelek és a többi alkatrész pontosan a számkra kijelölt helyen maradjanak.

GR**ΟΔΗΓΙΕΣ ΤΟΠΟΘΕΤΗΣΗΣ**

- Δεν επιτρέπεται να τον τοποθετήσετε μόνοι σας.
- Σημειώστε τον κωδικό του ραδιοφώνου.
- Αποσυνδέετε το καλώδιο γείωσης από τη μπαταρία.
- Για την αποφυγή ζημιών στη μόνωση των καλωδίων, να αποφεύγεται η επαφή τους με αιχμηρές ακμές.
- Προσέχετε, ώστε η πλεξούδα καλωδίων να περνά από τη σωστή θέση και να είναι στερεωμένη σύμφωνα με τους κανονισμούς.
- Τοποθετείτε τα τμήματα σύμφωνα με την εικόνα.
- Τοποθετείτε πάλι τα καλύμματα. Προσέχετε, ώστε η πλεξούδα των καλωδίων και τα άλλα τμήματα να είναι τοποθετημένα σύμφωνα με τους κανονισμούς και στη σωστή θέση τους.

SVK**Návod na inštaláciu**

- Nie kvôli tomu, aby ste to urobili.
- Skontrolujte rádiový kód.
- Odpojte uzemňovací kábel batérie.
- Aby ste zabránili poškodeniu káblových zväzkov, zabráňte kontaktu s ostrými hranami.
- Skontrolujte, či je káblový zväzok na svojom mieste a správne pripevnený.
- Nainštalujte diely podľa obrázkov.
- Znovu namontujte panely a uistite sa, že káblové zväzky a ostatné komponenty su prehľadne a bezpečne umiestnené.

PL**INSTRUKCJA INSTALOWANIA**

- Zestaw nie jest przeznaczony do montażu we własnym zakresie.
- Zanotować kod radia.
- Odłączyć przewód masy od akumulatora.
- Dla zapobieżenia uszkodzeniu izolacji chronić przed zetknięciem z ostrymi krawędziami.
- Upewnić się, że wiązka kablowa została ułożona we właściwym miejscu i prawidłowo zamocowana.
- Zamontować części zgodnie z rysunkiem.
- Na powrót osadzić osłony; zadbać aby wiązka kablowa i inne części były właściwie i dokładnie ułożone.

RUS**ИНСТРУКЦИЯ ПО УСТАНОВКЕ**

- Монтаж должны выполнять специалисты в мастерской.
- Отсоединить заземляющий кабель аккумулятора.
- Во избежание повреждений изоляции кабеля не допускать соприкосновения с острыми углами.
- Монтировать части согласно иллюстрации.
- Удостоверьтесь в том, что жгут проводов правильно проведён и прикреплён.
- С нова подключить аккумулятор.
- Установить панель, проверить правильность и точность расположения кабелей и других частей.

Subject to alteration without notice
Technische Änderungen vorbehalten
Reservadas modificaciones técnicas
Sous réserve de modifications techniques
Con riserva di apportare modifiche tecniche
Reservamo-nos o direito a alterações técnicas
Technische wijzigingen voorbehouden
Med forbehold for tekniske ändringer
Teknisk forendringer forbeholdes
Med reservation för tekniska ändringar
Tekniset muutokset pidätetään
Technické zmeny vyhradeny
A változtatások technika jogát fenntartjuk
Zmiany techniczne zastrzeżone
Επιφύλασσόμεθα για αλλαγές
Можно изменять без уведомления
Technické zmeny vyhradené

Info

- (GB)** Information
- (D)** Informationen
- (E)** Información
- (F)** Informations
- (I)** Informazioni
- (P)** Informações
- (NL)** Informatie
- (DK)** Information
- (N)** Informasjon
- (S)** Information
- (SF)** Tiedot
- (CZ)** Informace
- (H)** Információ
- (PL)** Informacja
- (GR)** Πληροφορίες
- (RUS)** информация
- (SVK)** Informácie



- (GB)** Look/See
- (D)** Siehe
- (E)** Ver
- (F)** Voir
- (I)** Vedere
- (P)** Cf.
- (NL)** Kijken naar
- (DK)** Se
- (N)** Se
- (S)** Se
- (F)** Katso
- (CZ)** Viz
- (H)** Lásd
- (PL)** Patrz
- (GR)** Βλέψτε
- (RUS)** См.
- (SVK)** Pozriť/Zobrazit



- (GB)** See Workshop Manual
- (D)** Siehe Werkstatthandbuch
- (E)** Ver manual de taller
- (F)** Voir Manuel d'atelier
- (I)** Vedere manuale officina
- (P)** Cf. o manual da oficina
- (NL)** Zie werkplaatshandboek
- (DK)** Se værkstedshåndbog
- (N)** Se verkstedshåndboka
- (S)** Se verkstadshandboken
- (SF)** Katso korjaamon käsikirjasta
- (CZ)** Viz dílenskou příručku
- (H)** Lásd a Műhely-kézikönyvből
- (PL)** Patrz podręcznik warsztatowy
- (GR)** λάτε Εγχειρίδιο Συνεργείου
- (RUS)** Смотрите руководство для мастерской
- (SVK)** Pozrite si dielenskú príručku



- (GB)** Warning
- (D)** Achtung
- (E)** Atención
- (F)** Attention
- (I)** Attenzione
- (P)** Atenção
- (NL)** Let op
- (DK)** Bemærk
- (N)** Pass på
- (S)** Varning
- (SF)** Huomio
- (CZ)** Pozor
- (H)** Figyelem
- (PL)** Uwaga
- (GR)** Προσοχή
- (RUS)** Осторожно
- (SVK)** Výstraha

4100-78-828A

[SDN]

MAZDA 3 BL

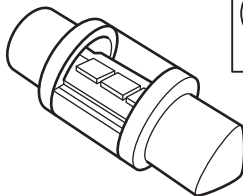
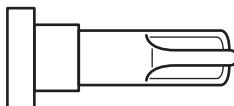
1 - 3
8 - 9
A

Info
Non-Polarity
3x
C

Info
Polarity
1x

4100-78-829B



【WGN】



MAZDA 6 GJ

MAZDA 6 GH



1

2

4

7

9

A

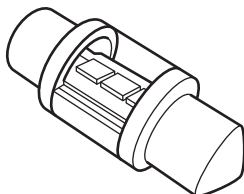

Non-Polarity

Info

5x

B

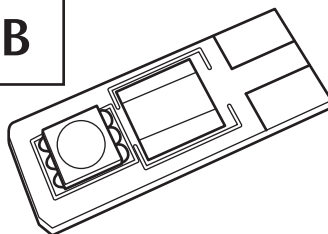

Polarity

Info

3x

4100-78-830B



【SDN】

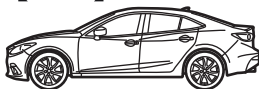

MAZDA 6 GJ

MAZDA 6 GH



1

2

4

6

9

A

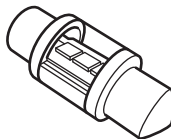

Non-Polarity

Info

4x

B

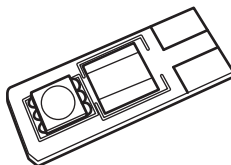

Polarity

Info

3x

C

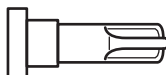

Polarity

Info

1x

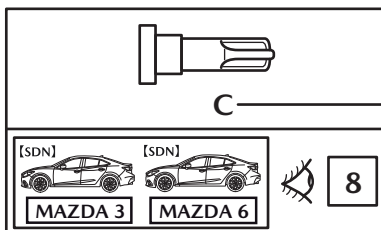
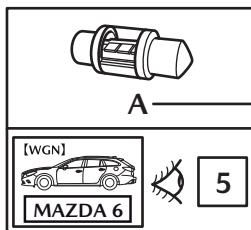
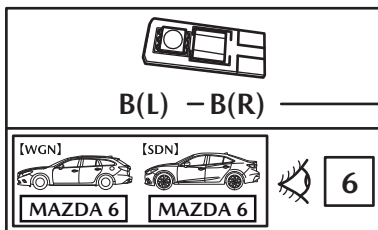
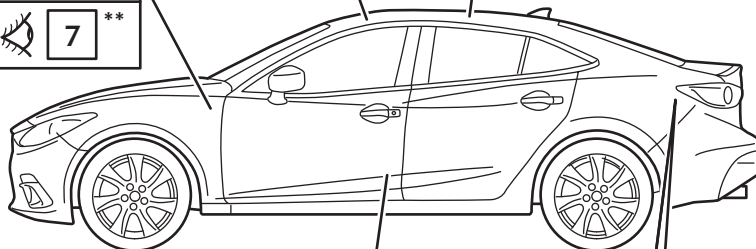
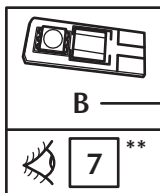
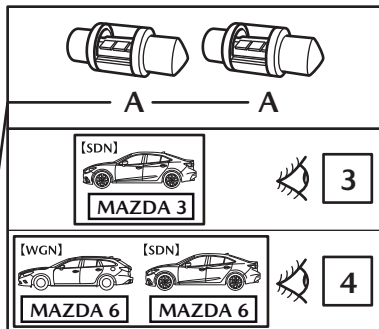
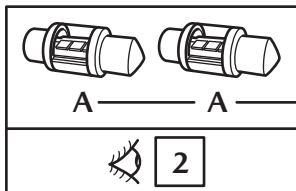
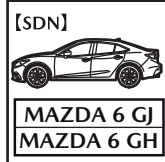
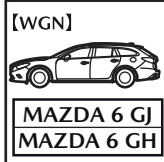

Info

** might not apply to all models

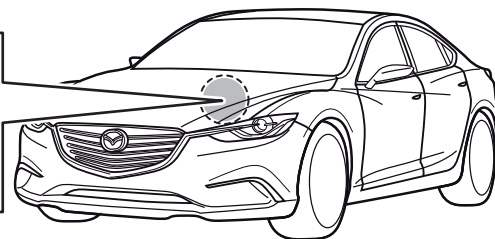
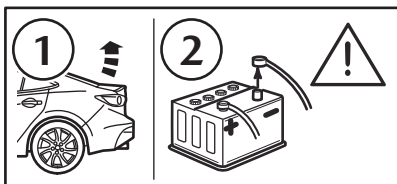
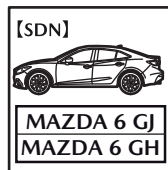
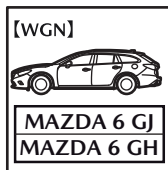
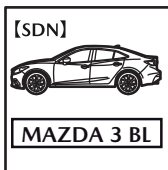

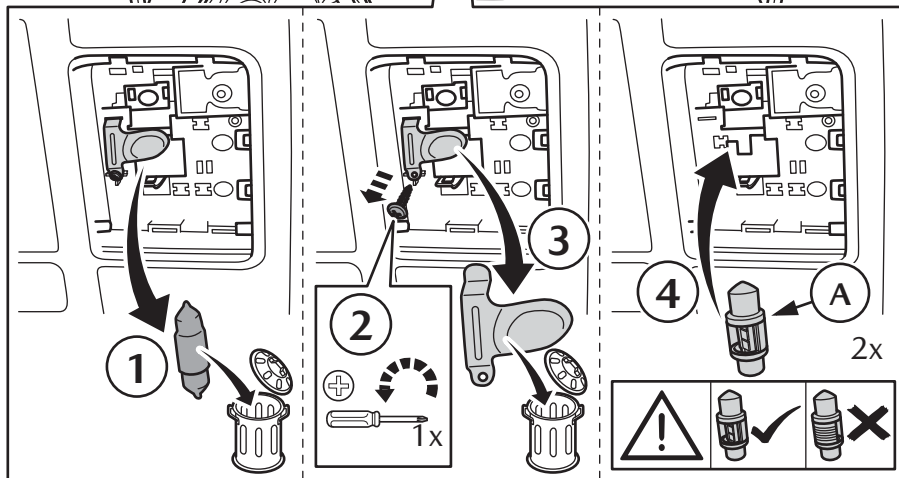
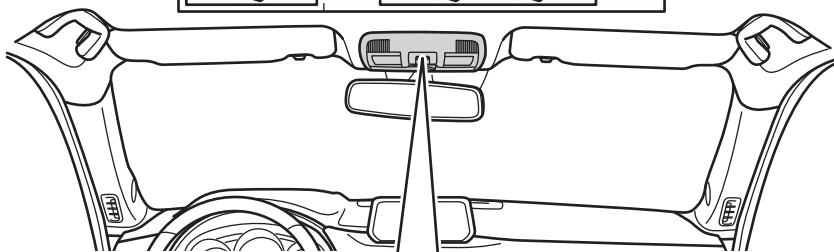
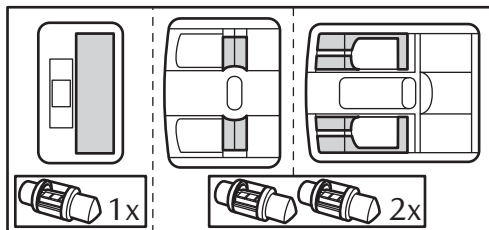
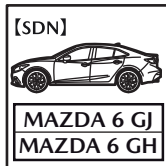
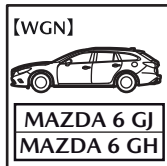
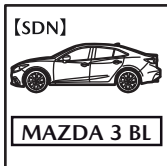
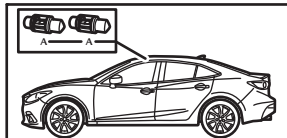

2



CAUTION: PREVENT CONTACT WITH METAL PARTS DURING INSTALLATION

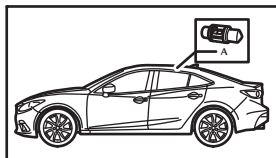

[SDN]

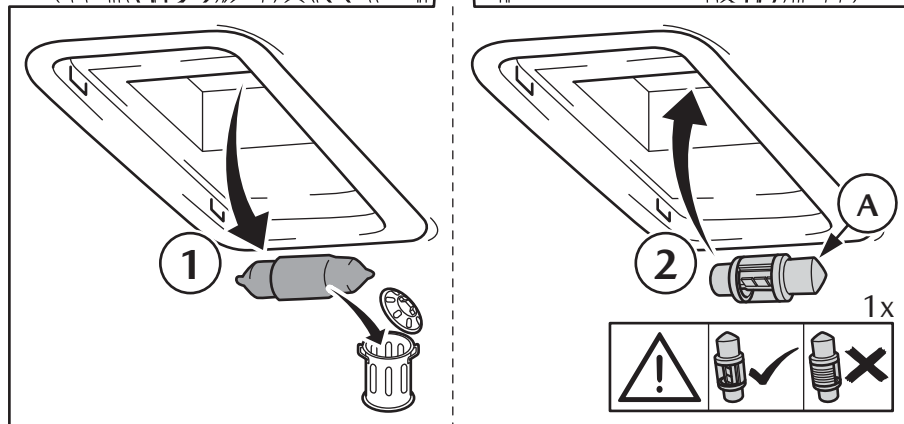
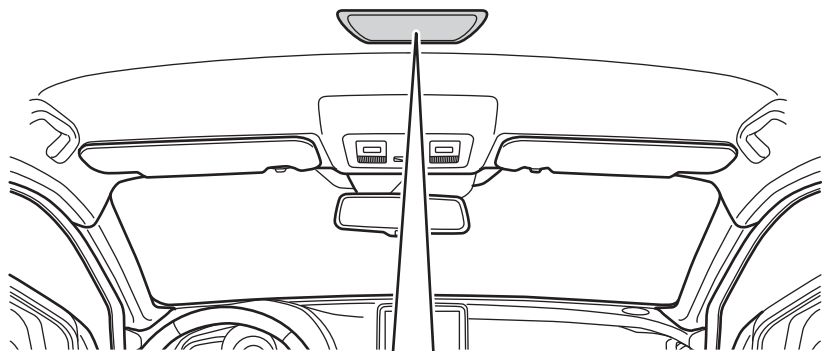

MAZDA 3 BL

**3****CAUTION: PREVENT CONTACT WITH METAL PARTS DURING INSTALLATION**

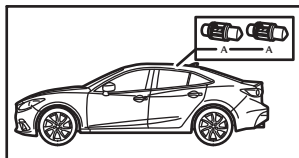

【WGN】

MAZDA 6 GJ
MAZDA 6 GH

【SDN】

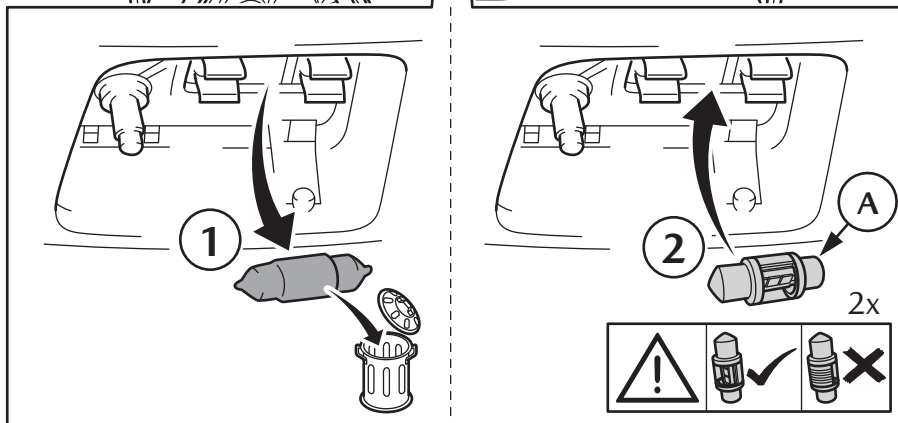
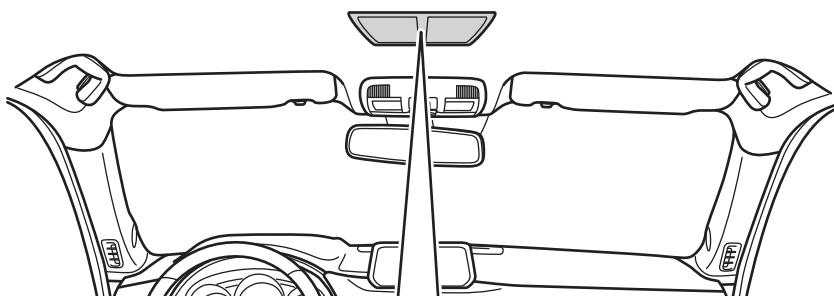
MAZDA 6 GJ
MAZDA 6 GH**4**

Info

**CAUTION: PREVENT CONTACT WITH
METAL PARTS DURING INSTALLATION**

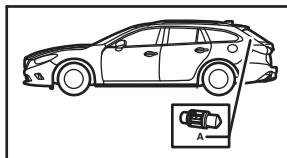

[WGN]

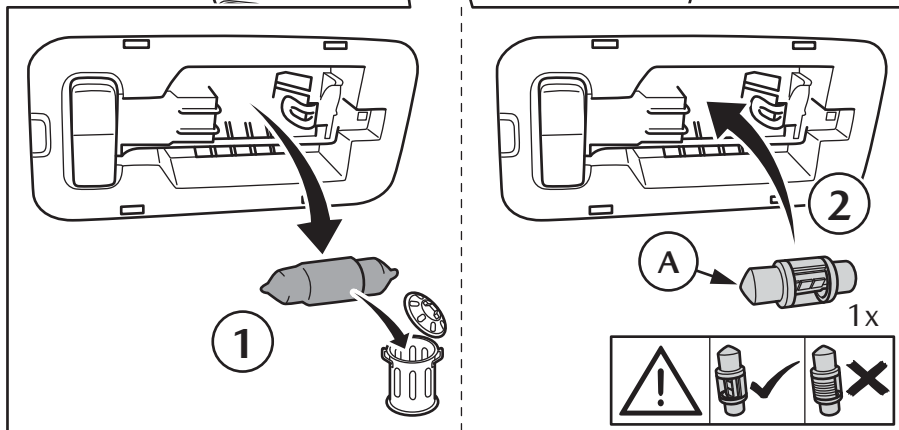
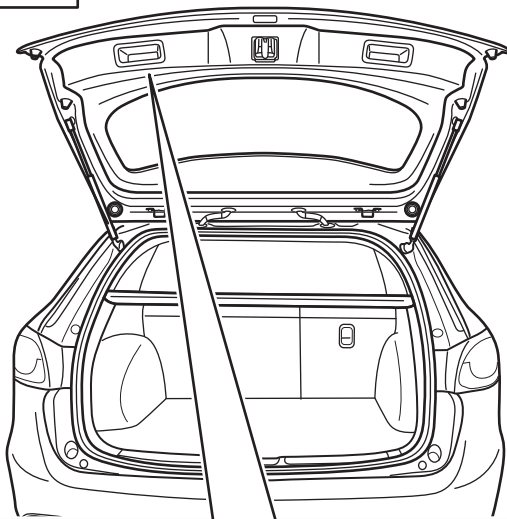
**MAZDA 6 GJ**
MAZDA 6 GH**5****CAUTION: PREVENT CONTACT WITH METAL PARTS DURING INSTALLATION**

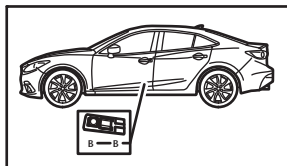

[WGN]

MAZDA 6 GJ
MAZDA 6 GH

[SDN]

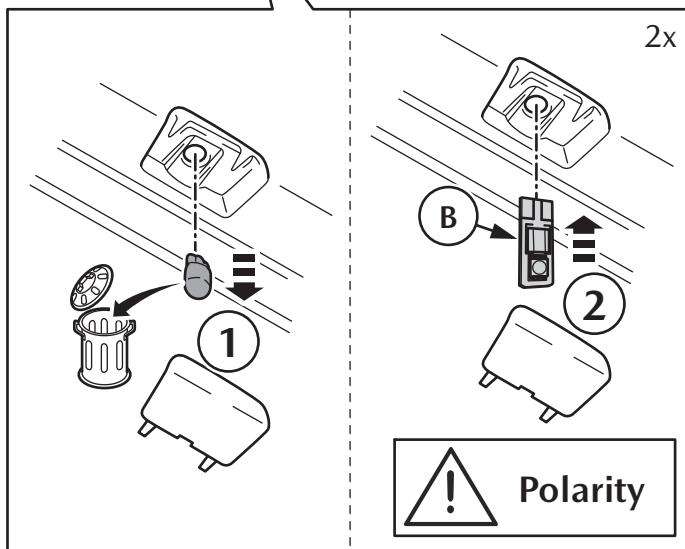
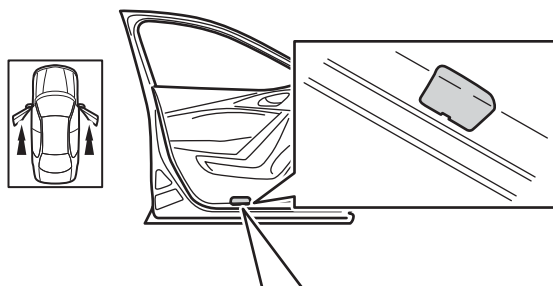
MAZDA 6 GJ
MAZDA 6 GH

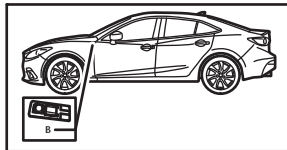

[WGN]

MAZDA 6 GJ
MAZDA 6 GH

[SDN]

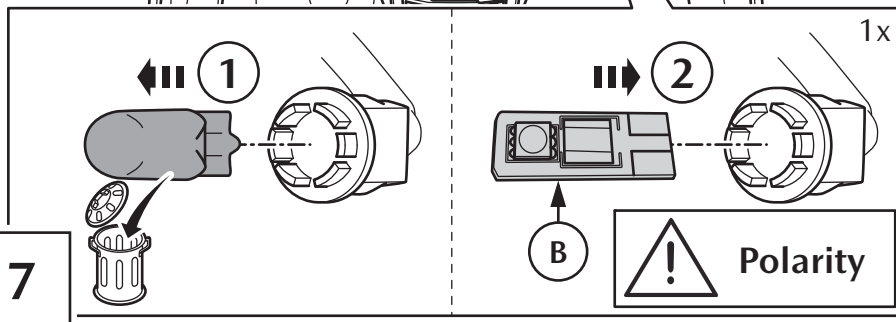
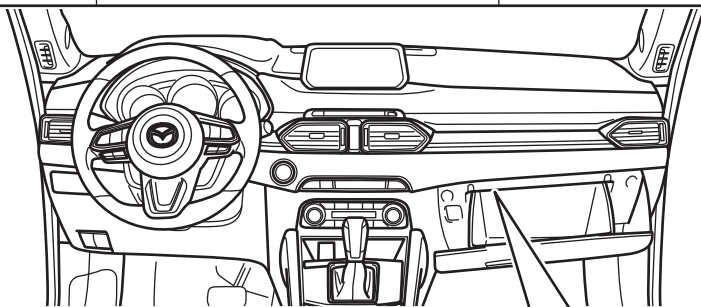
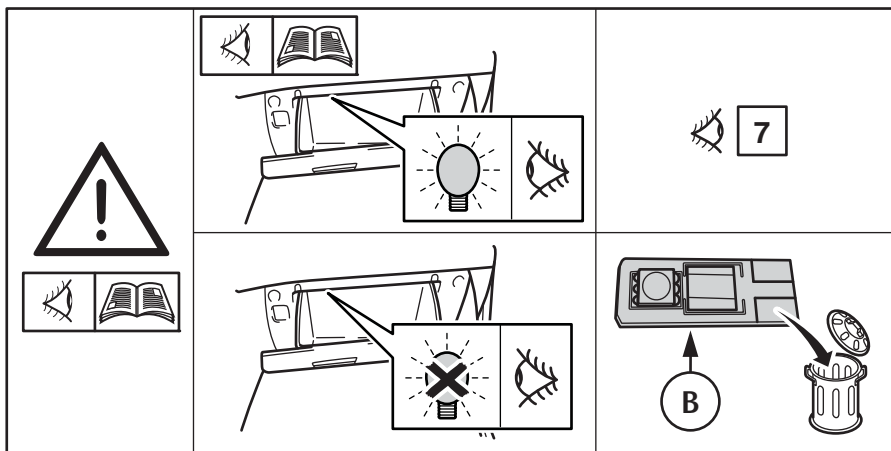
MAZDA 6 GJ
MAZDA 6 GH

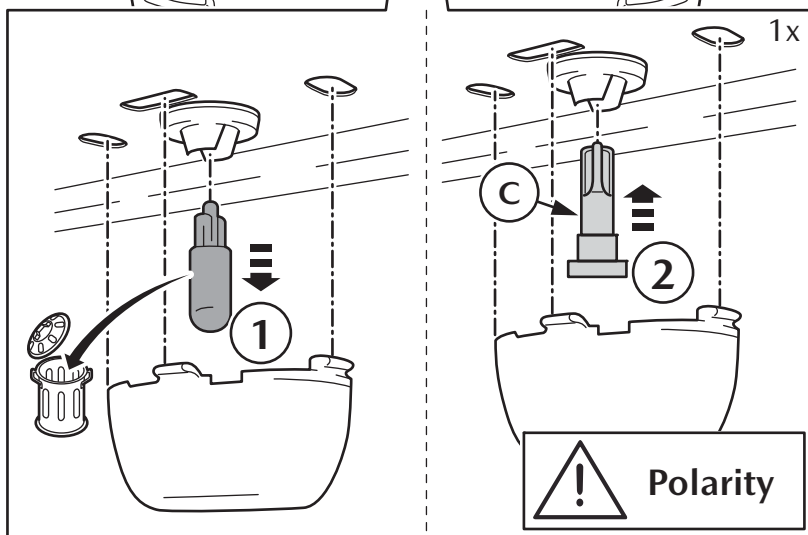
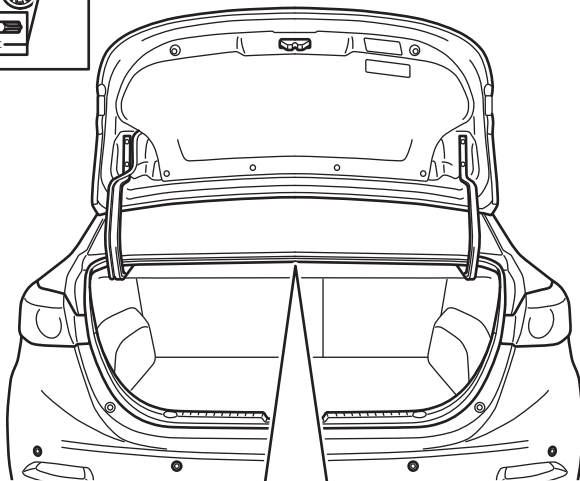
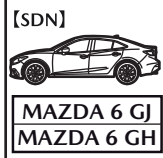
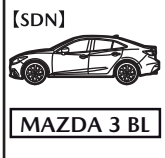
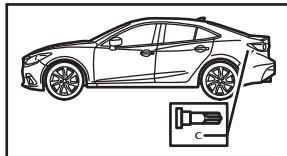

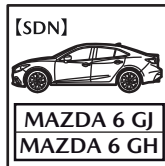
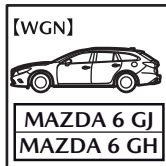
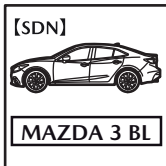

9

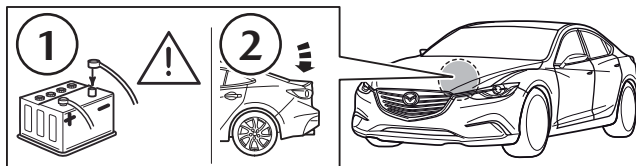

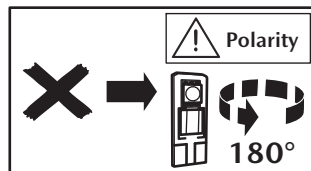
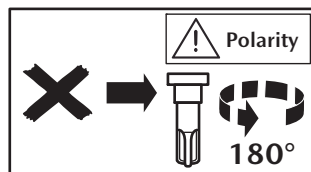
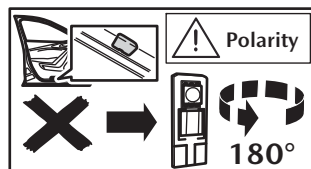

Subject to alteration without notice
Technische Änderungen vorbehalten
Reservadas modificaciones técnicas
Sous réserve de modifications techniques
Con riserva di apportare modifiche tecniche
Reservamo-nos o direito a alterações técnicas
Technische wijzigingen voorbehouden
Med forbehold for tekniske forandringer
Tekniske forendringer forbeholdes

Med reservation för tekniska ändringar
Tekniskt förbehåll förändringar
Technické zmeny vyhradeny
A változtatások technika jogát fenntartjuk
Zmiany techniczne zastrzeżone
Επιφύλασσομεθα για αλλαγές
Можно изменять без уведомления
Technické zmeny vyhradené